



REVO830

KUVINGS WHOLE SLOW JUICER

OPTIMIZED FOR CARROTS & CELERY

MANUAL

- Do not use parts in extremely hot water, dishwasher, dish dryer or microwave, etc.
- After you read this manual, keep in the place you can reach easily.
- Household use only.

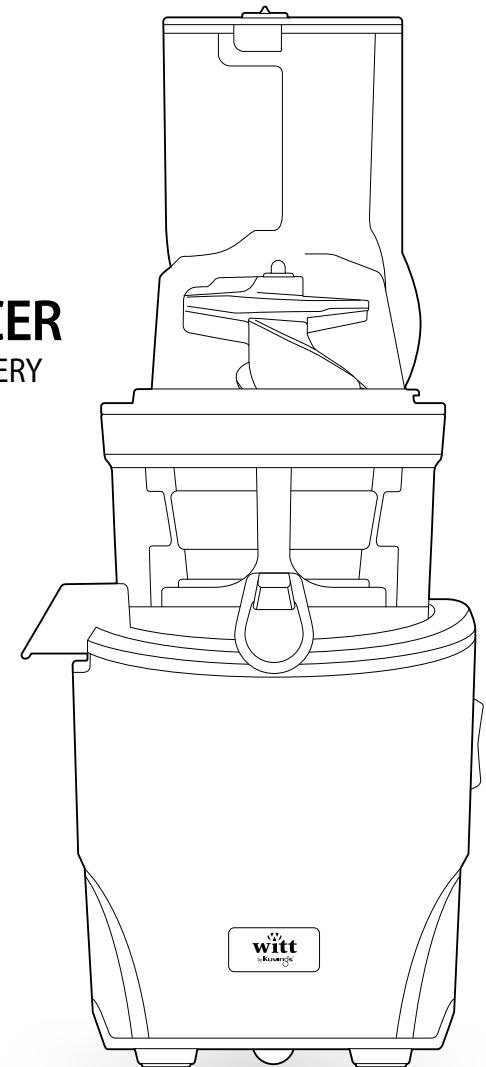

CONTENTS

34	Important Safeguards	53	How to Use the Cleaning Tool
36	Safety Warning		OPTIONAL How to use the Lid Cap
38	Parts	54	OPTIONAL How to Use the Blank Strainer
40	How to Assemble	56	OPTIONAL How to Use the Coarse Strainer
42	How to Operate	58	OPTIONAL How to Use the Smoothie Strainer
44	Tips on Operation	60	OPTIONAL How to Use the Citrus Maker
45	Tips on Ingredients	61	OPTIONAL How to Use the Lid Opener
46	Ingredients Preparation	62	Troubleshooting Q&A
51	How to Disassemble and Clean	63	Specifications
52	How to Clean Silicone Parts		

IMPORTANT SAFEGUARDS

When using electrical appliances, basic safety precautions should always be followed including the following:

1. Read all instructions.
2. To protect against risk of electrical shock, do not put motor or base of unit in water or other liquid.
3. Keep away from children.
4. Unplug from outlet when not in use, before putting on or taking off parts, and before cleaning.
5. Avoid contacting moving parts.
6. If the supply cord is damaged, it must be replaced by the manufacturer, its service agent or similarly qualified persons in order to avoid a hazard.
7. The use of attachments not recommended or sold by the manufacturer may cause fire, electric shock or injury.
8. Do not use outdoors.
9. Do not let cord hang over edge of table or counter.
10. Always make sure juicer cover is clamped securely in place before motor is turned on. Do not unfasten clamps while juicer is in operation.

11. Be sure to turn switch to OFF position after each use of your juicer. Make sure the motor stops completely before disassembling.
12. Do not put your fingers or other objects into the juicer opening while it is in operation. If food becomes lodged in opening, use food pusher or another piece of fruit or vegetable to push it down. When this method is not possible turn the motor off and disassemble juicer to remove the remaining food.
13. Do not use the appliance if the rotating sieve is damaged.
14. When a separable Juice Cup(1,2) is provided, do not operate without the Juice Cup(1,2) in place.
15. Please do not alter the appliance in anyway.
16. Do not use the appliance for anything other than it's intended purpose as described in the manual.
17. This appliance should be used for limited period of time.
18. This appliance can not be used by children and persons with reduced physical, sensory or mental capabilities or lack of experience and knowledge. Children shall not play with the appliance. Cleaning and user maintenance shall not be made by children.
19. This appliance is not intended for use by persons (including children) with reduced physical, sensory or mental capabilities, or lack of experience and knowledge.

SAVE THESE INSTRUCTIONS

- This appliance is for household use only. Please carefully follow the instructions in the manual.
(The appliance cannot be covered under the manufacture warranty if the product is abnormally or commercially used.)
- Save the instruction manual for future reference
- If the appliance is given away as a gift, please include the manual with the product.
- These instruction shall also be available in an alternative format.
e.g on a website. www.kuvings.com



SAFETY WARNING

The following precaution is provided to ensure the safety of the user. Please carefully read through the precautions and exercise a degree of care when using the appliance.

 **Warning** : Warns risk of death or severe injuries.







 **Caution** : Warns risk of injuries or appliance damage.

 Prohibited

 Must take action









 Do not disassemble

 Follow instruction

-  Do not plug multiple power cords on a single outlet during operation.
→ It may cause an explosion or fire.
-  Do not touch the power cord with wet hands.
→ It may cause electrical shock.
-  Do not leave the appliance unattended. Unplug the power cord from the outlet when not in use.
-  Use a dry towel to clean the power cord if it is dirty or wet.
→ It may cause electrical shock or fire.
-  Do not drop the appliance nor inflict strong force to the appliance.
→ It may damage or break the appliance.
-  Do not unplug by pulling off the power cord cable.
→ It may damage the power cord and cause electrical shock.
-  Do not put your finger or other objects into the feeding tube while it is in operation.
→ It may cause injury.



SAFETY WARNING

-  Do not put the parts in the dishwasher or extremely hot water.
→ The parts may wear faster.
-  Do not repair, disassemble the base, or customize the appliance.
→ The appliance may not operate properly causing fire, electrical shock or injury.
-  Do not use the appliance on an uneven surface.
→ It may cause a malfunction if the appliance tips over.
-  Keep away from children and store the appliance in a safe place.
→ It may cause injury.
-  Please do not store or operate the appliance near any heating appliance.
→ The appliance may become discolored or deformed.
-  Do not use any hazardous chemical to clean the appliance or flammable sprays near the appliance.
→ It may change the color of the appliance or could result in a fire.
-  To protect the power cord, please do not aggressively bend or put heavy object on top of the power cord.
→ It may cause short circuit or even fire.
-  Operating the juicer without ingredients can cause damage to the screw.
-  For cleaning parts that come in contact with food, please follow the instruction on pages 50-51.

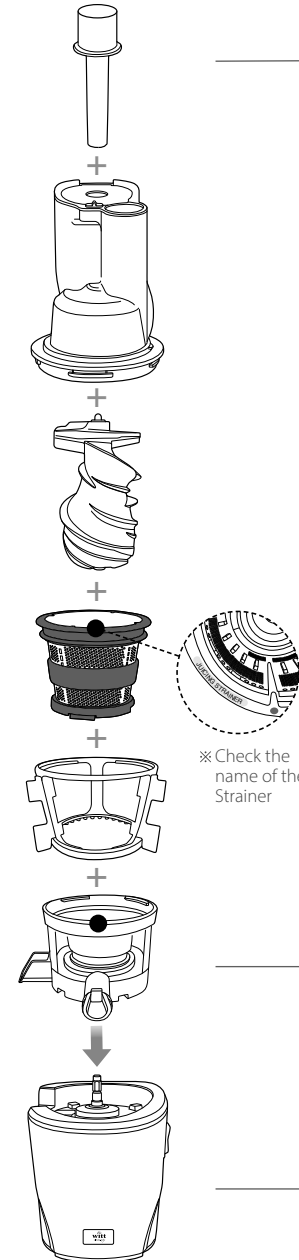
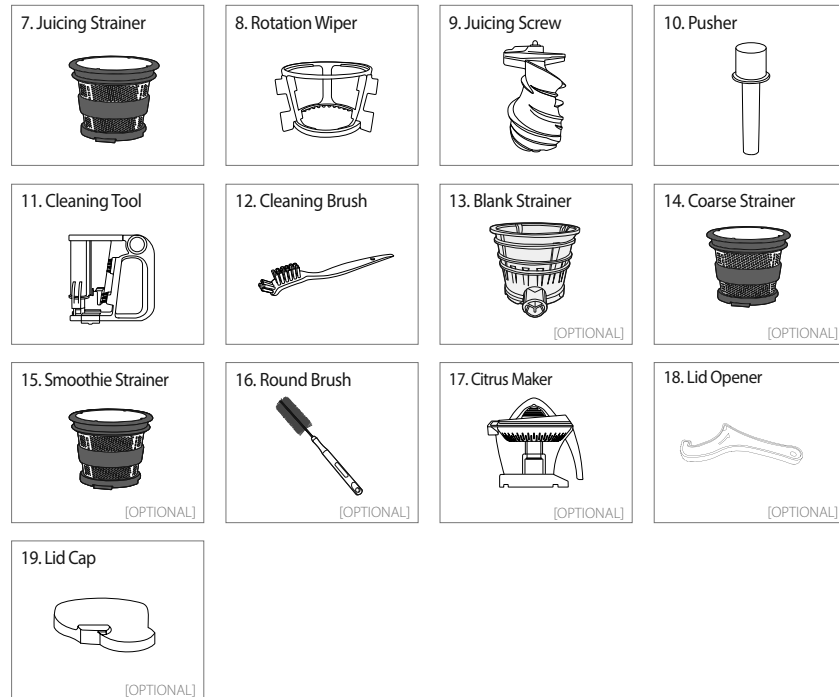
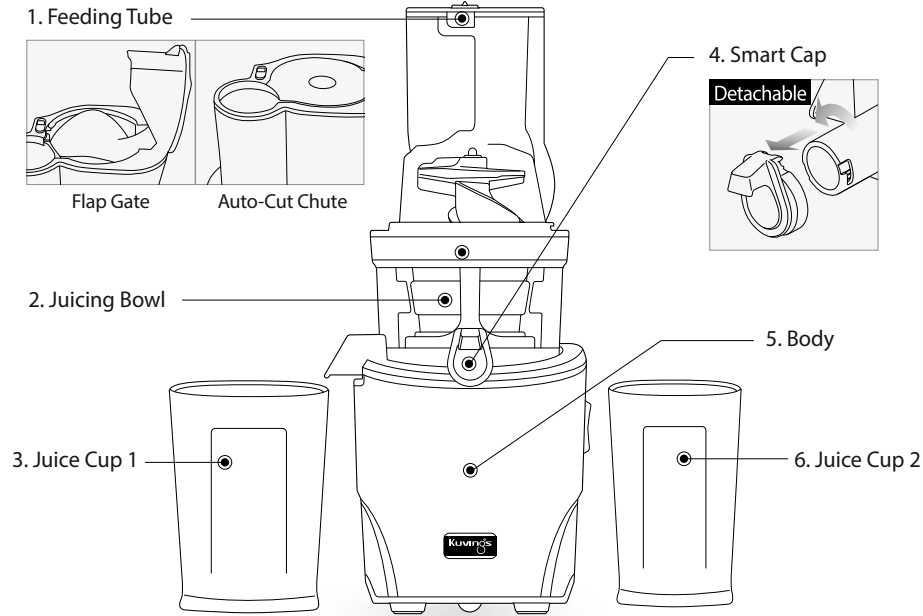

STEP 1

Top-set Assembly

Align the red dots ● on each part and assemble in the order shown. Once assembled, turn the drum lid clockwise to close.

STEP 2

Top-set and body assembly

Place the assembled Top-set on the body. Position the juice outlet so that it is in front of the body.

HOW TO ASSEMBLE

STEP 1 Top-set assembly

Check Before Operating

- Wash the parts before first use.
- **Do not use parts in extremely hot water, dishwasher, dish dryer or microwave, etc.**
- **Ensure that the silicone ring is assembled properly.**

- 1** Assemble the strainer into the rotation wiper then place this assembly in to the juicing bowl ensuring the red dot ● on the strainer is aligned with the red dot ● on the juicing bowl.

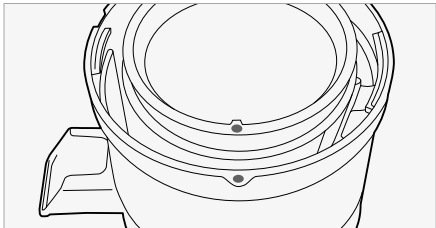
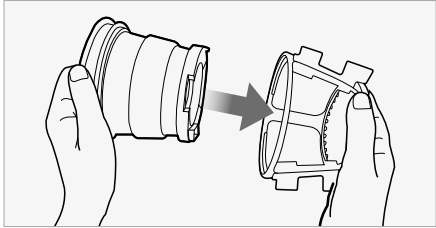

- 2** Place the juicing screw into the strainer. Turn and press down on it until it clicks into place.

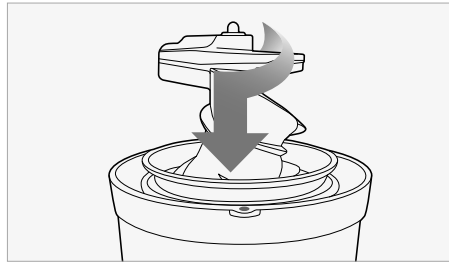

Note | The juicing screw needs to be locked in place in order to close the drum lid.

- 3** Place the drum lid onto the juicing bowl, aligning the white dot ○ on the drum lid with the red dot ● on the juicing bowl. Turn the drum lid clockwise until the lock mark ℳ on the lid is lined up with the red dot ● on the juicing bowl.

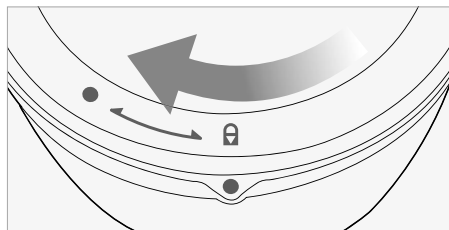
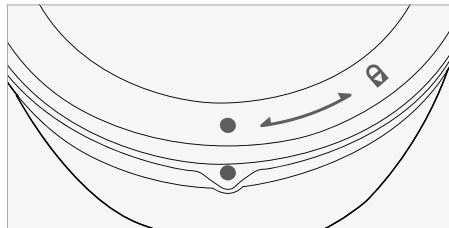

STEP 2 Top-set and Body Assembly

- TIP** For easy assembly hold the drum lid by grabbing the drum lid and turn clockwise as shown in the illustration.

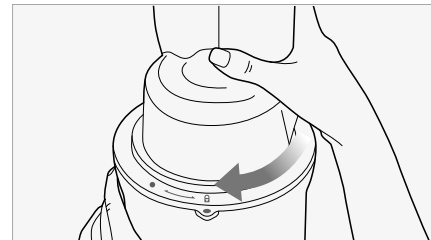
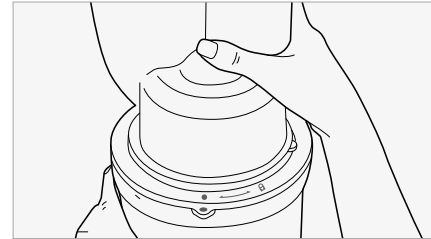

- 4** Place the assembled Top-set on the body. Position the juice outlet so that it is in front of the body.

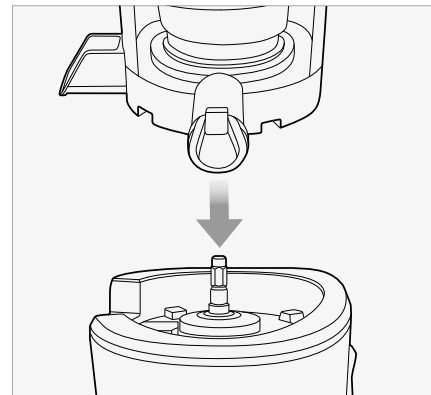

- 5** Place the juice cup 1,2 under the spout.



Note | When juicing with ingredients with high juicing content, place the juice cup 1 under the juice spout.

HOW TO OPERATE

After preparing the ingredients, plug the power cord into a wall outlet.

- Note |
- Do not touch the power cord with wet hands. It may cause electrical shock, short-circuit, or fire.
 - Ensure the power cord is plugged into a power outlet.



Press the FORWARD button to operate.

- Note |
- Forward: Pulls down and slowly masticates the ingredients.
 - Reverse: Pushes the ingredients back up to dislodge them.

If the ingredients become jammed in the screw and the drum lid does not open, press the OFF button. Then press and hold the REVERSE button until the ingredients become dislodged. Repeat REVERSE - OFF - FORWARD as often as needed to achieve the desired result.

If the juicer stops during operation

Switch the button to OFF position then press and hold the REVERSE button until the ingredients become dislodged. Repeat REVERSE - OFF - FORWARD as needed.

FORWARD : Pulls down the food
OFF : Stops the operation
REVERSE : Pushes the food back up

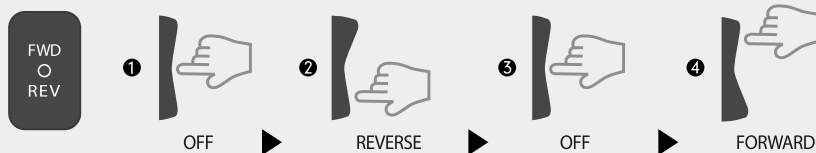

- Note |
- REVERSE: Pushes the ingredients back up to dislodge them. The REVERSE button only works while holding down the switch.
 - Switch OFF ensuring that the juicer comes to a complete stop. Then press REVERSE. Hold the REVERSE button for 2-3 seconds and release. Repeat as needed. Let the juicer stop completely before using the REVERSE button to prevent malfunction.
 - If the juicer does not work after these steps, disassemble and clean the parts before operating the juicer again.

Insert the prepared ingredients into the feeding tube, one piece at a time.

- Note |
- Prepare ingredients for optimal extraction.
 - If large quantity of ingredients are put into the feeding tube, it can cause the juicer to stop. Insert the ingredients one piece at a time.
 - Remove hard seeds or pits in fruits. When juicing frozen fruits, completely thaw before juicing.

Insert into the Auto-Cut Chute



Hard vegetables & high fiber foods | (E.g. carrots & celery, kale)

- Tip |
- Tough and fibrous ingredients: Ingredients with a thickness of 1.5 inches or less, can be fed whole. For thick ingredients, cut it by 1.5 inches of width or less, before feeding.
 - Fibrous leafy vegetables (celery, kale, collard greens, etc.): Cut the stems into 1.5 inch wide and bundle up the leafy part as you insert them into the juicer.

Insert into the Flap Gate



Soft Fruits & Vegetables | (E.g. apples, oranges & tomatoes)

- Tip |
- Soft ingredients: Insert the prepared ingredients into the flap gate and push down the ingredient with the flap gate lid to extract. If the ingredients are larger than the flap gate, cut ingredients into 1-4 pieces.



Smart Cap Use the smart cap to make mixed juice, block juice from dripping, or rinse between different juices.

- TIP |
- Juicing with the smart cap closed creates various mixed juice creations with different fruits and vegetables, milk, banana, beans and other ingredients.
 - After juicing, close the smart cap to stop juice from dripping, especially when disassembling the juicing bowl off of the base.
 - When making different juices, quickly rinse any left over flavors by running a glass of water in the juicer with the smart cap closed.

- Note |
- Leave the smart cap open when juicing ingredients that often creates foam during extraction. (e.g. apples, celery)
 - Pay close attention when operating with the smart cap closed. Juice may overflow if the juice collected in the juicing bowl exceeds its capacity.



After juice and pulp have been completely extracted, switch the unit OFF.

- Note |
- If the remaining ingredients in the juicing bowl have not been extracted completely, the drum lid may not open easily. (After each extraction, run the juicer for additional 30 seconds to let the juicer extract the remaining pulp.)

When the drum lid is stuck, press the REVERSE - OFF - FORWARD button in the order, switching back and forth 2~3 times to dislodge. Then place your hands on top of the drum lid and firmly press down as you simultaneously turn the drum lid counter clockwise to open.

※ Depending on the ingredients, pour water down the feeding tube to rinse out the interior of the juicing bowl and then try to take off the drum lid.





TIPS ON OPERATION

- 1. Operating the juicer without ingredients can cause damage to the screw.**
- 2. Do not continuously operate the juicer for more than 30 minutes.**
This can damage the motor from overheating.
After continuous use, let the juicer rest for 30 minutes to cool down before starting another session.
- 3. Do not put hand, utensil, tong, or other objects into the feeding tube other than the provided pusher.**
- 4. During operation, do not put spoon, spatula or other objects into the juice spout of the juicing bowl.**
If other object is put into the juice spout during operation, such materials can get stuck and damage the juicer parts.
- 5. Do not put dried whole grains, fruits with hard seeds or ice.**
These may damage the juicer parts (e.g. juicing bowl, juicing screw, and strainer).
 - Beans or grains can be used if soaked overnight or boiled.
 - Fruits with pits and hard seeds (e.g. nectarines, peaches, mangoes and cherries) must be pitted before juicing.
 - When using frozen fruits with small seeds such as grapes, completely thaw before inserting them into the juicer.
 - Use of ice in the juicer will decrease the product durability over time.
- 6. Do not use ingredients containing excessive amounts of vegetable oil or animal fat. Do not use the juicer to extract vegetable oil from ingredients.**
If vegetable/animal oil gets on the juicing screw, it may reduce performance and even damage the part.
- 7. Do not reinsert the extracted pulp into the juicer. This can cause the juicer to stop or cause the drum lid not to open.**
- 8. After juicing ingredients with seeds like grapes, thoroughly clean all the crevices on the bottom of the juicing screw.**

TIPS ON INGREDIENTS

Juicer damage due to owner negligence or from not following the instructions in the owner's manual will void the warranty service.

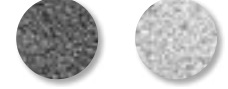
DO NOT put the following ingredients into the juicer

Hard seeds		Peach, nectarines, apricot, plum, mango, etc. Remove hard seeds from the ingredients before juicing.
Hard or inedible skins		Pineapple, melon, mango, orange, etc. Peel the skins from the ingredients before juicing.
Frozen fruits or ice		Frozen strawberry, blueberry, raspberry, etc. Completely thaw frozen fruits before juicing. Do not use ice.
Vegetable/ animal oil		Sesame seed, butter, margarine, etc. Do not extract ingredients containing vegetable or animal oil. This can reduce performance and even damage the juicer.
Others		Coconut, sugarcane, whole grains, etc. Do not extract ingredients with no water content.

Experience the best quality juice by understanding each ingredient's characteristics and knowing the optimal way of handling the ingredients.

The Slow Juicer is an innovative product that uses a patented slow-speed masticating technology to efficiently extract the juice from ingredients. The juicer is designed to obtain the best result from ingredients with firm composition and with high water content. For best result, each ingredient should be prepared and extracted depending on its characteristics and properties.



INGREDIENTS PREPARATION

Before Operating:

- Before Operating: If the juicer is jammed or if the drum lid does not open, press the REVERSE button and hold until it becomes dislodged. Repeat REVERSE-OFF-FORWARD as needed.
- Continue operating the juicer until all the ingredients in the juicing bowl are extracted. The drum lid may not open easily if there is a lot of pulp remaining in the juicer.
- Every ingredient yields different amounts of juice.

Juice Yield:

- For the optimal extraction and maximum juice yield, cut the ingredients following the guidelines given in this section.
- Insert ingredients slowly monitoring how the ingredients are extracted. The juice yield may vary depending on the juicing speed.

Soft fruits and vegetables (e.g. apples, oranges, tomatoes)

Flap Gate



- Peel the skin off oranges, and for tomatoes and apples, take out the stem.
- Slowly insert the ingredients down the flap gate.



1~4 wedges

- If the ingredients are larger than the flap gate cut the ingredients into pieces that will fit into the flap gate.

PREPARATION TIPS:

- If the ingredients are larger than the flap gate, cut to 1-4 wedges.

JUICING TIPS:

- Fruits with hard seeds must be pitted before extraction.
- Use the pusher to push the ingredients down the feeding tube. (The pusher also helps prevent juice from spraying out of the feeding tube when extracting ingredients with high water content)
- Leave the smart cap open when juicing ingredients that create excessive foam during extraction. (Foam can accumulate if operated with the smart cap closed.)
- It is recommended that the extracted juice be consumed within 48 hours after extracting. Depending on the density of the ingredients the extracted juice can gradually show layers over time.
- When an ingredient is being masticated by the juicing screw, the squeezed ingredient may splash juice through the feeding tube. Use the pusher to block out the juice splash when juicing.

Ingredients with small seeds (e.g. raspberry, pomegranate, grape)

Slowly insert ingredients with small seeds to prevent the seeds from clogging the strainer.

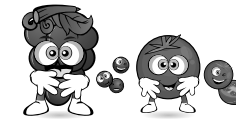
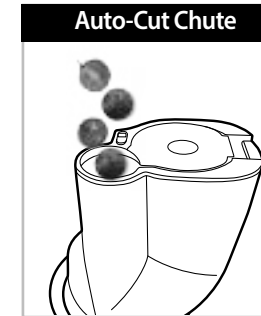

Insert ingredients slowly to minimize the amount of leftover seeds in the strainer.

PREPARATION TIPS:

- Thoroughly rinse ingredients like grapes. Take the grapes off and discard the stem.
- For best result, juice with ingredients with higher amount of fluid (e.g. apple, pear)
- When juicing frozen ingredients (e.g. raspberry, strawberry), make sure they are completely thawed.

JUICING TIPS:

- Depending on the size of the grape, insert 3~5 grapes at a time while monitoring the extraction result.
- Thaw frozen ingredients like pomegranate and raspberry then insert about 1 tablespoon (5g) at a time.
- Frozen ingredients usually lose significant amount of fluid from thawing. When juicing, mix milk or yogurt to balance the fluid lost.

- ⚠ **Caution** | If the lid does not open due to excessive amount of small seeds left in the juicing bowl, continuously run the juicer for 30 second to extract any leftover seeds. If the lid is still stuck, repeat REVERSE - OFF- FORWARD until the ingredients become dislodged. Place both hands on the drum lid and firmly press down while simultaneously turning the drum lid to open. (depending on the ingredient, pour some water down the feeding tube for quick rinsing to help dislodging).

INGREDIENTS PREPARATION

How to Use the Smart Cap:

- Juicing with the smart cap closed allows mixed juice creations with different fruits, vegetables and liquids.
- After juicing, close the smart cap to block excess juice from dripping, especially when disassembling the juicing bowl off the body.
- When making different juices quickly rinse away any leftover flavors by running a glass of water in the juicer with the smart cap closed.
- Leave the smart cap open when juicing ingredients that create excessive foam during extraction (e.g. apples, celery).
- Pay close attention when operating the juicer with the smart cap closed. Juice may overflow if the juice collected in the juicing bowl exceeds its capacity marked on the juicing bowl.

Adjusting the amount of pulp in the juice:

- Depending on the ingredient, you may get extra pulp in the juice when juicing continuously.
- To reduce the amount of pulp, disassemble the top-set and wash frequently.

Hard fruits and vegetables (e.g. carrots, beets, ginger, kohlrabi, quince)

Hard fruits and vegetables may put excess strain onto the motor and cause it to stall.

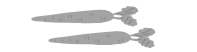
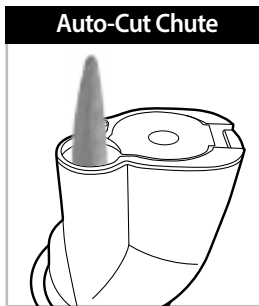

Ingredients with a thickness of 1.5 inches or less, can be fed whole. For thick ingredients, cut it by 1.5 inches of width or less, before feeding.

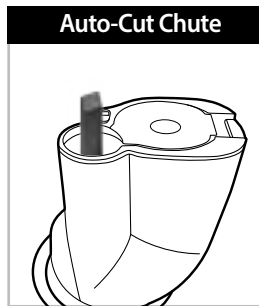

Beets, ginger, quince and kohlrabi are cut into 1 inch or less interval for horizontally and vertically.

⚠ Caution | Do not juice root vegetables with less moisture such as beets, ginger, or kohlrabi, or hard fruits like quince by itself.

* When juicing alone, it may cause the decrease the performance of product.

PREPARATION TIPS:

- Prepare carrots after removing the stem.
- Soak ingredients like carrots in cold water for about 30 min prior to juicing for the best result.

JUICING TIPS:

- Slowly insert the ingredients one at a time.
- To maximize the juice yield, juice with ingredients with high water content.

Fibrous and/or tough leafy ingredients (e.g. celery, kale)

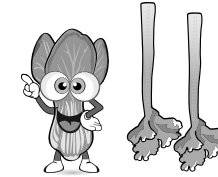
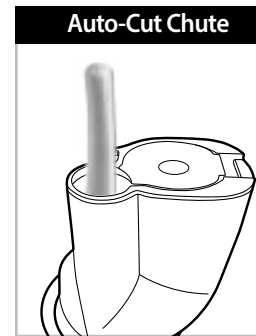

Bundle up the leafy part and insert them by facing down. Do not collect more than 500g per session.

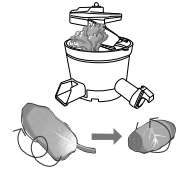

If leafy ingredients wrap around the juicing screw, open the lid and remove the fibers before continue juicing.

PREPARATION TIPS:

- Separate each stem. Cut the outer stems that are thick and tough to 1.5 inch wide.
- Soak the leafy greens in cold water for about 30 min prior to juicing for the best result.

JUICING TIPS:

- One at a time, slowly insert the prepared ingredients.
 - Insert more ingredients after the previously inserted ingredients have been completely extracted.
 - ① Roll leaves into spiral as inserting into the juicer.
 - ② For bet result, disassemble and wash the top-set before juicing again.
 - ③ For ingredients like wheatgrass, grab a handful and insert in a bundle.
 - * It's best to juice with ingredients with higher amount of fluid, like apples or carrots.
- carrot, apples : fibrous ingredients = 9:1 [recommended ratio]

- ⚠ Caution |**
- For ingredients like pineapple, slice off the rind of the pineapple and cut around the fibrous core. Cut the flesh of the pineapple to smaller pieces.
 - Recommended amount of juicing per session is 500g. When juicing more than 500g, wash the top-set before continue juicing.

HOW TO DISASSEMBLE AND CLEAN

Check Before Cleaning

- Wash the parts before first use.
- Do not use parts in extremely hot water, dishwasher, dish dryer or microwave, etc.

1 Switch OFF and unplug the power cord from the wall outlet.

- Note |
- Extract all the remaining pulp in the juicing bowl before stopping the juicer.
 - For easier clean up, operate the juicer for an additional 30 seconds after the juice is extracted.
 - When the drum lid is stuck, press the REVERSE – OFF – FORWARD button in this order, switching back and forth 2 to 3 times to dislodge. Then place both hands on the drum lid and firmly press down while simultaneously turning the drum lid to open.
- * Fill the juicing bowl with water and run the juicer before opening the drum lid. It may help to open the drum lid when stuck.

2 Turn the drum lid counter clockwise to open.

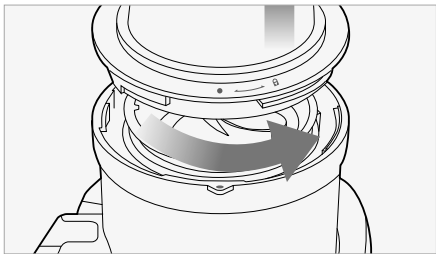

- Note |
- When moving the appliance, do not lift by grabbing the feeding tube. Always lift the appliance by grabbing the body or handle.

3 Turn the top-set counter clockwise and lift off the body.

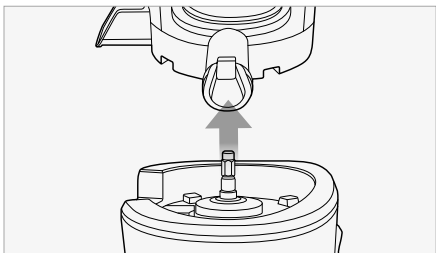

4 Remove the juicing screw, strainer and rotation wiper unit from the juicing bowl. Clean with provided brush.

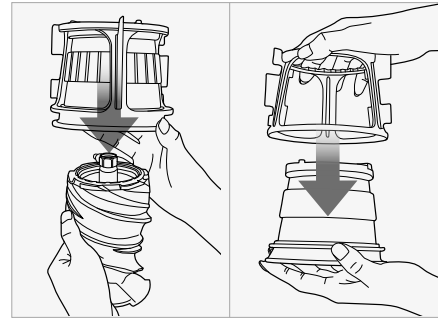

- Note |
- Immediately clean the juicer after each use. If remaining residue in the juicer dries up, it can make disassembling and clean-up difficult. The excess build up can cause poor performance in future uses.
- For easier disassembly, place the top-set in the sink and run the water through from the top of the top-set.
- Thoroughly dry the bottom of the juicing screw.

5 Place the juicing bowl under running water.



- TIP |
- The round brush can clean the juice spout of the juicing bowl.

6 Under running water, clean the outside of the juicing screw with a dish scrub. Use the tip of the cleaning brush to push out any residue in the crevices on the bottom of the juicing screw.

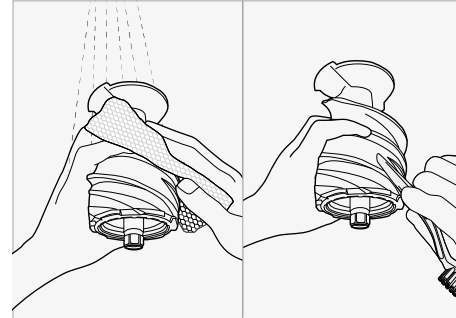

- Tip |
- Thoroughly clean the juicing screw ensuring that the juicing screw is clean without any residue.
 - Completely dry before using.

- Note |
- After juicing ingredients with seeds, make sure to thoroughly clean the bottom crevice of the juicing screw. (If this area isn't properly cleaned, it can cause the part to be damaged).

7 Clean the body with a soft damp towel and dry.



- Note |
- If the towel is dripping wet, make sure to squeeze out the excess liquid before using it on the juicer.

* The products illustrated in this booklet may vary slightly from the actual product.

Quick Rinsing

1 With the smart cap closed, fill the juicing bowl with water and turn on the juicer.

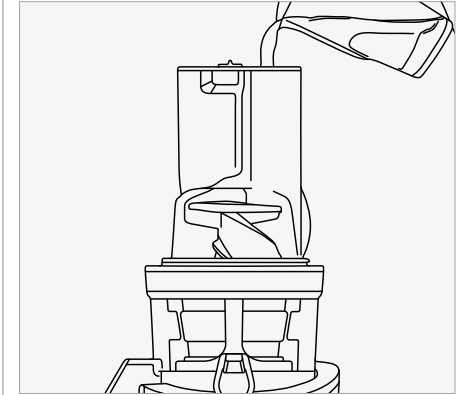

2 Let it run for a moment. Open the smart cap and let the water run out of the juicing bowl.



- Tip |
- It is not necessary to completely clean the juicer in between making multiple juices during a single juicing session.
 - When finished with juicing, always disassemble and clean thoroughly between juicing sessions to prevent residue buildup.

HOW TO CLEAN SILICON PARTS

Tip | Clean the rotation wiper under running water. Thoroughly dry after cleaning. Before assembling the top-set, ensure that the silicon ring is firmly inserted.

Note | If the silicon ring is not firmly inserted, juice may leak from the bottom of the juicing bowl.

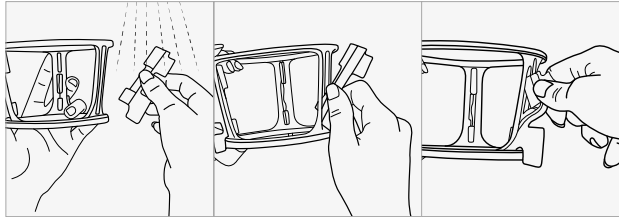

Silicon Brush

Pull out the silicon brush from the rotation wiper to clean. After cleaning, insert into the slot with the tail pointing down as shown in the illustration.

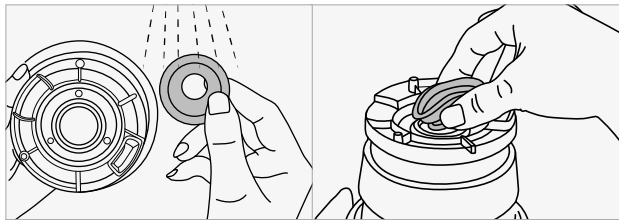

Silicon Ring

Remove the Silicon ring from strainer to clean. After cleaning, push in the silicone ring.

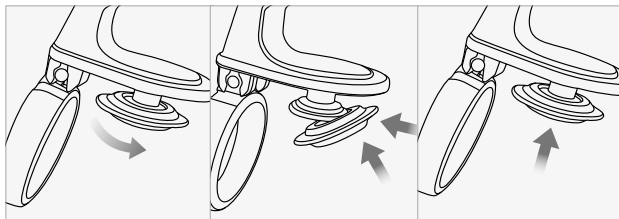

Smart Cap

Remove from the juice spout to clean. After cleaning, attach the smart cap to the smart cap silicon on the juice spout.

Cleaning inside of the bowl

Please unscrew the cover on the bottom and clean inside. After cleaning, make sure that protrusion part of gear is placed on the outer part so it fits (connects) with the drum. Sequence of assembly is in reverse order of disassembly.

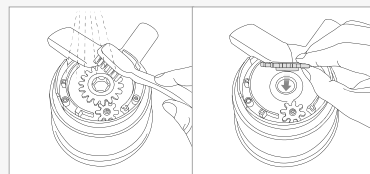

HOW TO USE THE CLEANING TOOL

*The products illustrated in this booklet may vary slightly from the actual product.

Tip | The cleaning tool makes clean-up quick and easy. Completely dry after cleaning.

1 Push the slide lock of the dual cleaning tool toward the handle to release it.

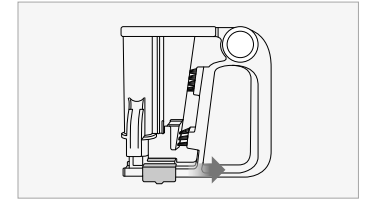

2 After inserting the fastening bar into the silicon ring groove in the center of the strainer, then lower the handle.

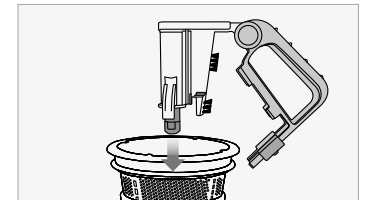

3 In that state, push the slide rock at the bottom with the strainer and tighten it.

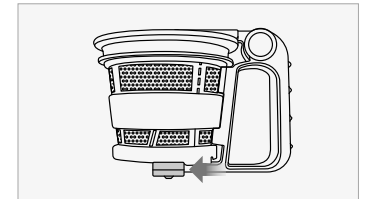

4 Wash from side to side while rotating the dual cleaning tool and strainer in opposite directions under running water.

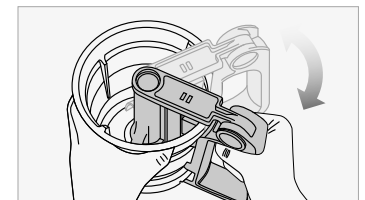

OPTIONAL | HOW TO USE THE LID CAP

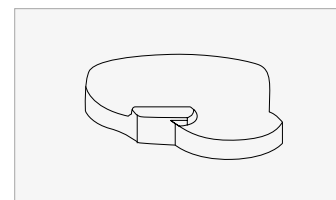

Once washing & drying of drum lid is completed, put on Lid cap on drum lid to store.

OPTIONAL | HOW TO USE THE BLANK STRAINER

* Dissemble is opposite of Assemble.

❗ Before use, make sure the silicone ring is correctly in place.

1 To assemble the top-set place the juicing screw and the blank strainer in the juicing bowl and close the lid.

- ① Insert the blank strainer into the juicing bowl while aligning the red dots ● of the blank strainer and the juicing bowl.
- ② Insert the juicing screw into the blank strainer with a twisting motion.
- ③ Place the lid onto the juicing bowl by aligning the white dot ◐ of the lid with the red dot ● of the juicing bowl. Then, rotate the lid clockwise until the lid is secured.

※ When using the blank strainer, always leave the Smart Cap open.

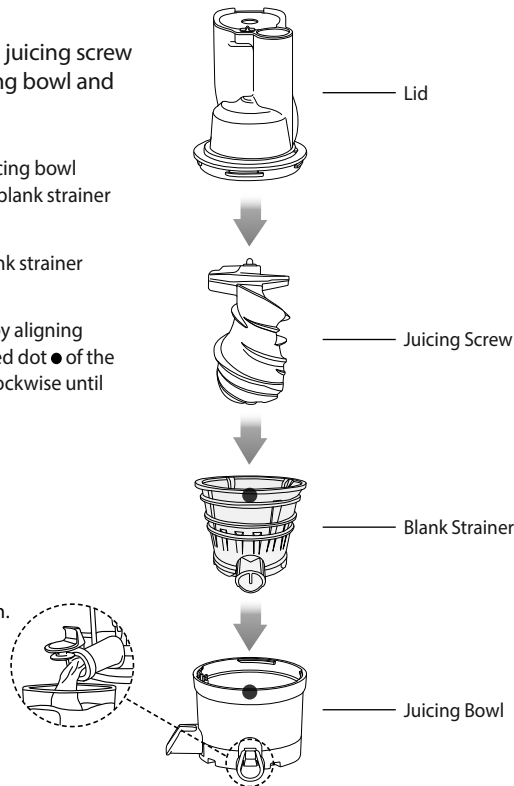

❗ CAUTION

The blank strainer is used only with frozen ingredients. Depending on the different ingredients, allow the frozen items to thaw for 5 to 20 minutes before use. Slowly process a smaller amount per batch.



- ※ Do not use ice or process ingredients containing vegetable or animal oil. It may cause a malfunction.
- ※ Remove hard seeds from the ingredients and peel the skins from the ingredients before juicing.

HOW TO CLEAN THE SILICON RING

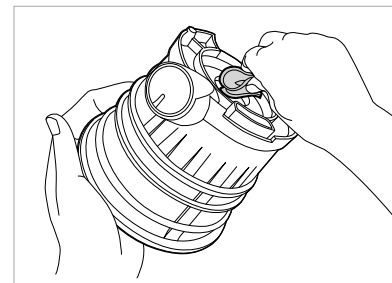

The silicon ring is removable for cleaning. After cleaning, place the silicon ring on as shown in the picture.

TIP | Carefully place the silicon ring by aligning grooves and wedges.

OPTIONAL | HOW TO USE THE COARSE STRAINER

* Dissemble is opposite of Assemble.

! Make sure to insert the coarse strainer into the rotation wiper before use.

1 To assemble the top set, place the juicing screw and the coarse strainer in the juicing bowl and close lid.

- ① Insert the rotation wiper and the coarse strainer into the juicing bowl while aligning the red dot ● of the coarse strainer and the juicing bowl.
- ② Insert the juicing screw into the coarse strainer with a twisting motion.
- ③ Place the lid onto the juicing bowl by aligning the white dot ◯ of the lid with the red dot ● of the juicing bowl. Then, rotate the lid clockwise until the lid is secured.

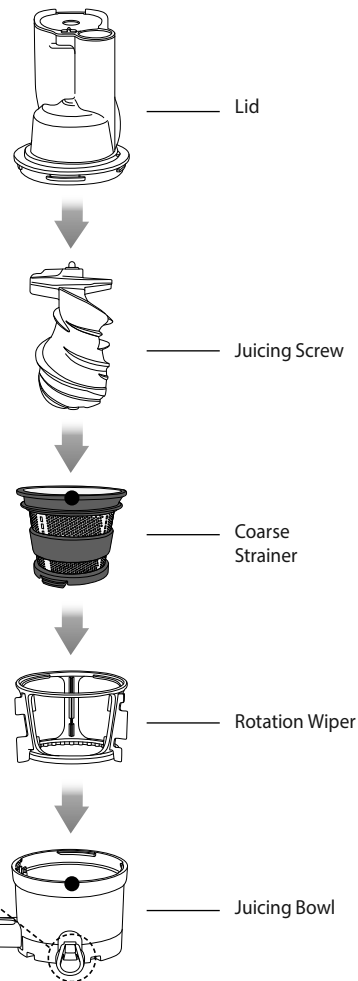

※ When using the coarse strainer, always leave the Smart Cap open.



! CAUTION

- When using "COARSE STRAINER" make sure to remove any hard seeds or pits from ingredients.
- Remove skin or rind that is tough, hard and/or leathery.
- When juicing frozen ingredients, make sure they are completely thawed, do not use ice.
- Do not try to juice ingredients containing vegetable or animal oil. This can reduce performance and even damage the juicer.
- Do not put the following ingredients into the juicer; coconut, kudzu, sugarcane, whole gains etc.



1 To assemble the top set, place the juicing screw and the smoothie strainer in the juicing bowl and close the lid.

- ① Insert the rotation wiper and the smoothie strainer into the juicing bowl while aligning the red dots ● of the smoothie strainer and the juicing bowl.
- ② Insert the juicing screw into the smoothie strainer with a twisting motion.
- ③ Place the lid onto the juicing bowl by aligning the white dot ◉ of the lid with the red dot ● of the juicing bowl. Then, rotate the lid clockwise until the lid is secured.

※ When using the smoothie strainer, make sure the smart cap is closed to make the better smoothie.

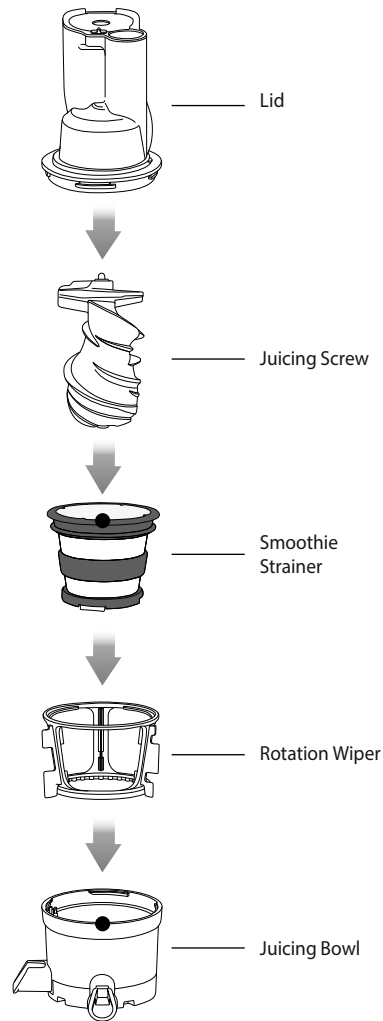

! CAUTION

When using frozen ingredients, make sure to thaw your frozen ingredients for about 5 to 20 minutes before use.

(The required period to thaw the ingredients will depend on how long the ingredients were in the freezer and the temperature it was kept in).



When making smoothie, add milk or other types of liquid between ingredients.

Check the consistency of the smoothie by looking through the juicing bowl, and add more liquid as needed.

- ※ Please do not insert ingredients like ice, meat, oil or fat based ingredients. These ingredients may damage the components.
- ※ Please remove hard or thick seeds, pits, or peel before use.

HOW TO CLEAN THE SILICON COVER

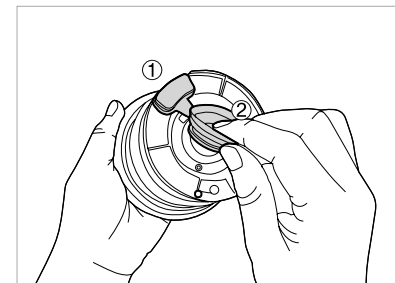

The silicon cover is removable for cleaning. After cleaning, place the silicon cover in regular sequence on as shown in the picture.

TIP | Carefully place the silicon cover by aligning grooves and wedges.

OPTIONAL | HOW TO USE THE CITRUS MAKER

- ❗ Citrus juicer will not work unless it is properly aligned and placed onto the juicer as shown in the illustration.

1 How to assemble

- 1 Place the strainer and cone onto the center of the juicing bowl.

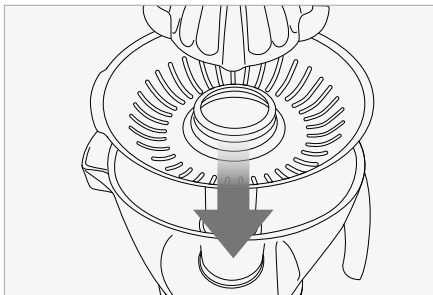

- 2 Place the assembled top set onto the juicer body making sure that it is aligned as shown.

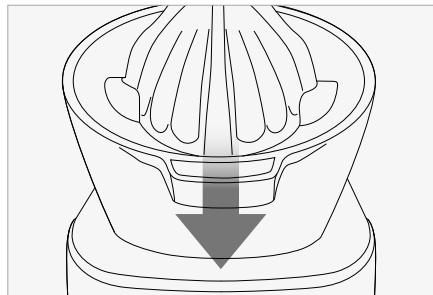

2 How to operate

- 1 Remove the protective lid.

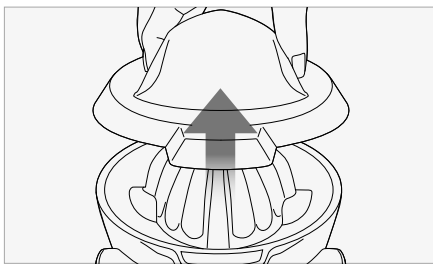

- 3 Citrus maker will not work unless it is properly aligned and placed onto the juicer.

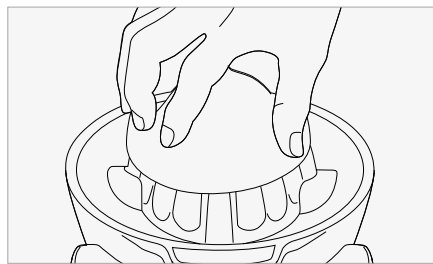

- 2 Turn the juicer on by pressing FWD.

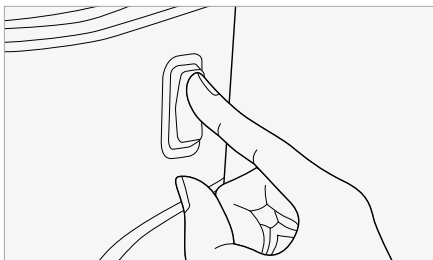

- 4 If there is too much pulp, clean the cone and strainer.

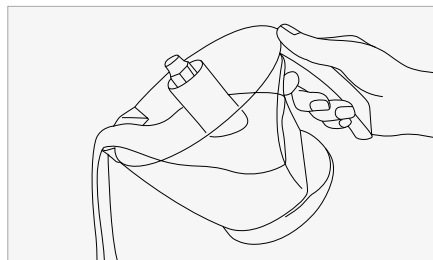

OPTIONAL | HOW TO USE LID OPENER

- ❗ Use the lid opener when the lid doesn't open gently after juicing.

- 1 Place the lid opener by connecting the hooks as shown in the illustration.

- ❗ **CAUTION** Be sure that the top set is on the main body, then use lid opener.

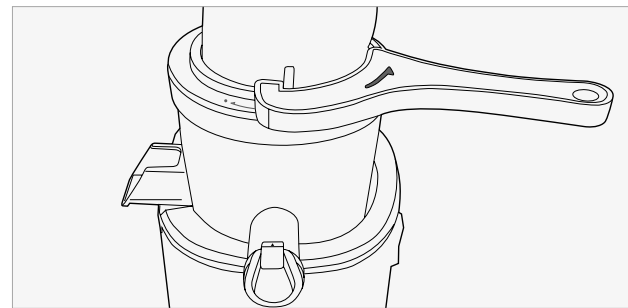

- 2 Grab the feeding tube and turn the lid opener counter clockwise.

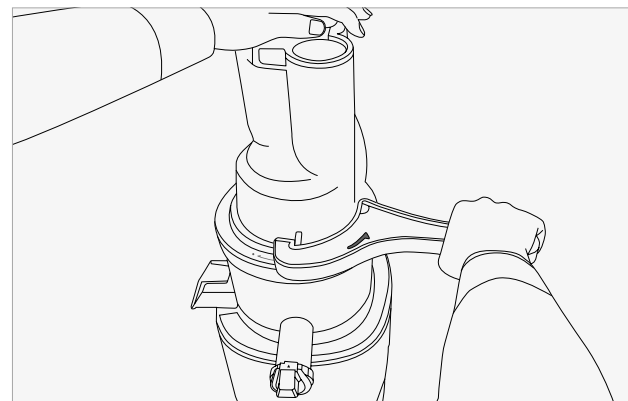

TROUBLESHOOTING Q&A

■ When there is no power to the juicer:

- Check if the power cord is properly plugged in.
- Check if the drum lid and the juicing bowl are properly assembled.
- Check if the top-set and the body are properly assembled.
- Juicer will not operate if parts are not assembled properly.

■ Low juice yield:

- Different ingredients hold different amounts of fluid that will yield different amounts of juice.
- If the ingredients are not fresh, they may contain reduced amount of fluid, which will yield less juice. Sock ingredients in cold water for about 30 min prior to juicing for the best result.
- If the ingredient itself has low water content, it may help to soak it in water before juicing.
- If juicing ingredients with small seeds, after a few servings, it may reduce the juice yield. For best result, disassemble and wash the top-set in between juicing.
- If there is seed residue on the bottom of the strainer, this can affect juicer performance and the overall juice yield.

■ There is too much pulp in the juice:

- To reduce the fine pulp, clean the top-set frequently and extract the pulp.
- If the strainer and the screw are damaged and affecting the juicer's performance, it is recommended the parts be replaced.
- * The lifetime of each part may vary depending on length and method of use and ingredients extracted.

■ The drum lid will not close:

- Make sure the juicing screw is pushed all the way in to the strainer in order for the drum lid to close properly.
- If the juicing screw is not properly in position, the drum lid may not close.

■ Odd noise from the juicer:

- Check if the parts are assembled correctly. Try reassembling the parts and listen for the odd noise.
- Do not start the juicer unless there are ingredients and/or liquid in it.
- Operating the juicer without ingredients can cause damage to the screw.
- If the juicer is operated without ingredients or liquid, the noise level can increase and also can lead to damage.
- The friction noise from the juicing screw and the strainer will disappear when ingredients are inserted into the juicer.
- If the noise occurs when ingredients are inserted into

the juicer, check the size of the ingredients. Do not insert anything over 1.5 inch in thickness.

- Depending on the type of ingredients, the dimensions can be smaller.
- The noise can occur if the juicer is operated on an uneven or slanted surface. Place the juicer on a horizontally flat surface when operating.

■ The extracted pulp is very moist:

- During the very beginning of extraction, the pulp can be more moist.
- Depending on the ingredient's condition, the extracted pulp can be affected; especially when the ingredient is not fresh, the juice can be extracted with the pulp.

■ During operation, the juicing bowl shakes:

- The juicing screw and the strainer are set up to crush and squeeze the ingredients. It is normal for the juicing screw and the strainer to vibrate.
- If the ingredient contains strong fiber, the vibration from the top-set may be stronger.

■ During juicing, the juicer stopped:

- Check the power cord and make sure it is plugged in correctly.
- Check that all the parts are correctly assembled.
- If too many ingredients are inserted at one time, this can cause the juicer to stop.
- When the juicer stops because there are too many ingredients inserted in it, press the REVERSE - OFF - FORWARD button in this order, switching back and forth 2 to 3 times.
- The reverse setting will push the ingredients up, and the forward setting will pull the ingredients down.
- After using more than 30 minutes, if the juicer stops due to the overload protection, let the juicer cool for 30 minutes to 1 hours before juicing again.
- If there are hard seeds within the ingredients, remove them before juicing. Hard seeds can damage the juicer.

■ Layers of separation in the juice:

- Depending on the density of the ingredients, the extracted juice may show layers of different juices. It is different from separation due to oxidation caused by juicing with a high-speed juicer.

■ The drum lid is stuck:

- After juicing, let the juicer operate for another 30 seconds to extract the remaining pulp.
- If there is too much pulp in the top-set, this can cause the drum lid to not open. In this situation, press

TROUBLESHOOTING Q&A

- the REVERSE-OFF-FORWARD button in the order, switching back and forth 2 to 3 times. Then place both hands on the drum lid and firmly press down while simultaneously turning the drum lid to open.
- Pour water down the feeding tube to rinse out the insides and then try opening the drum lid.

■ Juice dripping down the body:

- If the silicon ring on the bottom of the strainer is not put in correctly, the juice may seep out on to the juicer body. Before assembling the parts, check and make sure the silicon ring has the flat part in the middle, on the inside of the strainer and the skirt on the outside of the strainer.

■ Is it possible to juice ingredients with tough fiber?

- Ingredients like celery or ginger contain long fibers that may wrap around the juicing screw and affect the juicer's performance. When juicing fibrous ingredients, do not collect more than 1 lb. of juice. After collecting this quantity or less, clean the top-set completely before juicing again.

■ Discoloration of the plastic parts:

- After juicing, if the juicer is not cleaned right away, the remaining pulp inside the top-set can dry up which can make disassembling and

cleaning hard. This can also affect the juicer's performance and color.

- Ingredients that are rich in carotenoids such as carrots and spinach may dye plastic parts. When the parts are dyed with carotenoids, rub vegetable oil in to the dyed areas and use mild detergent to clean.
- Vegetable oil should only be used during clean-up for parts that are discolored. Do not use vegetable oil on the juicing screw or the strainer. If vegetable oil or oil from animal fat gets on the juicing screw or the strainer, this can affect the juicer's performance and may result in damaged parts.
- The silicone pieces on the top-set can be detached to be thoroughly cleaned.

■ Using for purposes other than juicing:

- This juicer is designed to juice ingredients like fruits and vegetables.
- Do not use the juicer for extracting vegetable oil.
- Do not juice ingredients with high contents of vegetable/ animal oil.
- If vegetable/animal oil gets on the juicing screw or the strainer, this can affect the performance of the juicer and could result in damaged parts.

SPECIFICATIONS

Product	Juicer
Model	REVO830, KSP-2428CB, KSP-2458CB, KSP-2428CE, KSP-2458CE
Voltage	AC220-240V, 50/60Hz
Power Consumption	200W
Maximum Use	Less than 30 min
Weight	7.5kg
Dimension	256 x 210 x 480 mm
Manufacturer	NUC Electronics Co., Ltd.
Type	Low speed compression
Origin	Made in Korea